

Energizer®

HANGING DECORATIVE PENDANT

GB IMPORTANT **FR** IMPORTANT! **DE** WICHTIG! **IT** IMPORTANTE!
ES ¡IMPORTANTE! **PT** INFORMAÇÃO IMPORTANTE **NL** BELANGRIJK!
SE VIKTIGT! **NO** IVIKTIG! **DK** VIGTIGT! **FI** TÄRKEÄÄ!

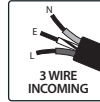

GB Installation must be installed by a qualified electrician (BS7671).

FR L'installation doit être effectuée par un électricien qualifié (BS7671).

DE Die Installation sollte von einem qualifizierten Elektriker durchgeführt werden (BS7671).

IT L'installazione deve essere effettuata da un elettricista qualificato (BS7671).

ES La instalación debe ser realizada por un electricista autorizado (BS7671).

PT A instalação deve ser feita por um electricista profissional.

NL Laat de installatie uitvoeren door een electricien.

SE Installationen skall utföras av en behörig elektriker.

NO Installasjonene skal utføres av en behørig elektriker.

DK Installationen skal foretages af en elektriker.

FI Asennuksen saa tehdä vain valtuutettu sähköasentaja.

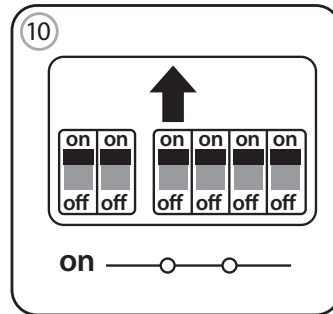
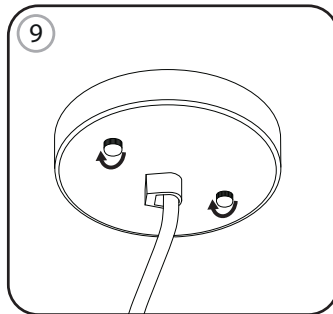
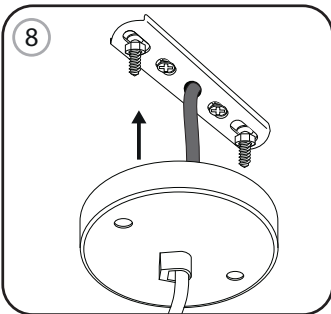
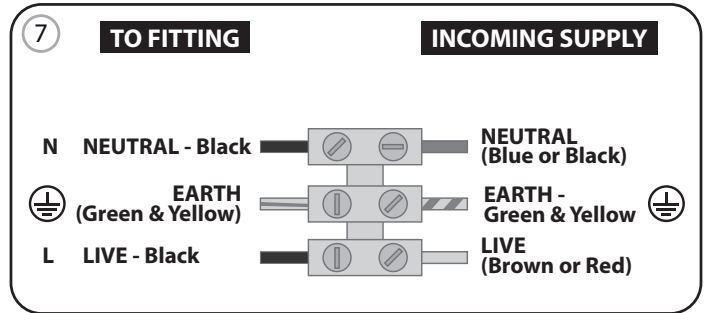
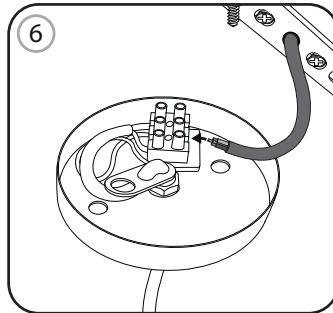
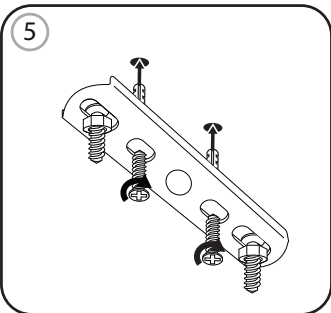
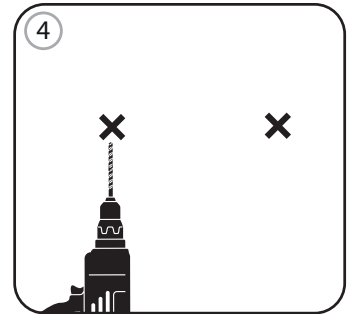
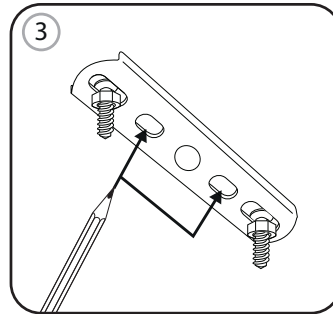
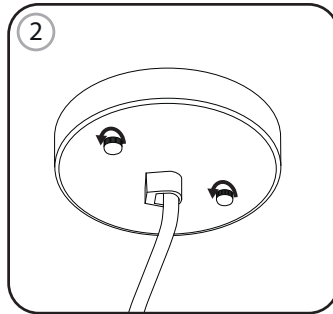
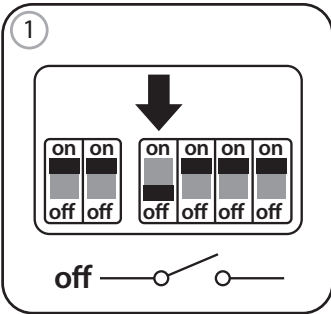
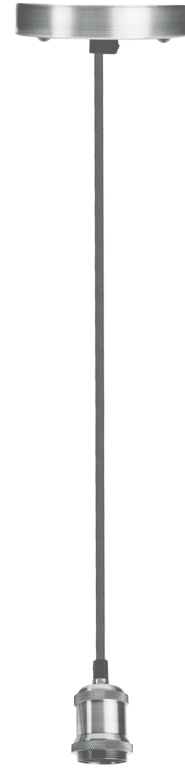

©2019 Energizer. Energizer and certain graphic designs are trademarks of Energizer Brands, LLC and related subsidiaries and are used under license by Supreme Imports Ltd. All other brand names are trademarks of their respective owners. Neither Supreme Imports Ltd nor Energizer Brands, LLC is affiliated with the respective owners of their trademarks.